

300W 10R Prism King Beam Moving Head Light

PRISM KING

USER MANUAL



CONTENTS

Chapter 1	Installation and attention	1
1.1	Maintenance	1
1.2	Statement	1
1.3	Safety Precaution	1
1.4	Product Instruction	1
1.5	Cable connection (DMX)	2
1.6	Rigging (Optional)	2
Chapter 2	Panel operation	4
2.1	Brief	4
2.2	Operation	4
2.2.1	Operate light with touch or KEY	4
2.2.2	Parameter value setting	4
2.2.3	Boolean parameter setting	5
2.2.4	Sub Menu (Parameter)	5
2.3	Operation and parameter instruction	6
2.3.1	ADDR--> Address: Set DMX Address	6
2.3.2	MODE--> WorkMode: Set Light work mode	6
2.3.3	DISP-->DISPLAY: Set display	7
2.3.4	TEST--> TestMode	7
2.3.5	ADVA-->Advanced: Set light run parameter	8
2.3.6	STAT-->Status: View status	9
Chapter 3	Channel description	10
3.1	Channel table	10
3.2	Channel Detail	11 错误! 未定义书签。
3.2.1	COLOR Detail	错误! 未定义书签。
3.2.2	GOBO Detail	错误! 未定义书签。

Chapter 1 Installation and attention

1.1 Maintenance

- To reduce the risk of electrical shock or fire, do not expose this unit to rain or moisture.
- Intermittently using will extend this item's service life.
- Please clear the fan ,fan net , and optical lens in order to keep good work state.
- Do not use the alcohol or any other organic solvent to wipe the shell.

1.2 Statement

The product has perfect performance and integrity packing. All users should be strictly complying with the warning and operating instructions as stated. Or we aren't in charge of any result by misusing. Any damage resulting by misuse is not within the Company's warranty. Any fault or problem caused by neglecting the manual is also not in the charge of dealers.

Note: All information is subject to change without prior notice.

1.3 Safety Precaution

- In order to guarantee the product's life, please don't put it in the damp places or even the environment over 60degrees.
- Always mount this unit in safe and stable matter.
- Install or dismantle should operate by professional engineer.
- Using lamp, the change rate of power voltage should be within $\pm 10\%$. If the voltage is too high, it will shorten the light's life; If it's not enough, will influence the effect.
- Please restart it 20 minutes later after turning off light , until full-cooling. Frequent switching will reduce the life span of lamps and bulbs; intermittent using will improve the life of bulbs and lamps.
- In order to make sure the product is used well, please read the Manual carefully.

1.4 Product Instruction

- lamp: MSD 300w (life:2200 hours Color temperature: 8000K)
- Channel mode:16 DMX512 Channel
- Pan scan: 540°(16bit) Electric correction
- Tilt scan: 270° (16bit) Electric correction
- Amazing dot matix, four tact switch, 180° turning show
- Color wheel: one color wheel, 14 kinds of color chips in one color wheel
- Gobo: 14 gobos
- Effect Wheel: Rotation 48 prism+8 prism, effect move , frost
- 0-100% mechanical dimming, mechanical dimming and free dimming available.
- strobe macro control available.

- Lens optical system achanical fouce .beam angle 0~4°
- Over heat protection
- Power Input: 100-240V, 50/60Hz
- Power Dissipation: 350W
- IP level :IP20
- Magnetic ballast and AC/Dc power supply
- Product Size: 523×337×511mm
- Packing Size: 635X440X725
- Net weight: 19.5KG

1.5 Cable connection (DMX)

Use a cable conforming to specifications EIA RS-485: 2-pole twisted, shielded, 120Ohm characteristic impedance, 22-24 AWG, low capacity. Do not use microphone cable or other cable with characteristics differing from those specified. The end connections must be made using XLR type 3 or 5-pin male/female connectors. A terminating plug must be inserted into the last projector with a resistance of 120Ohm (minimum 1/4 W) between terminals 2 and 3.

IMPORTANT: The wires must not make contact with each other or with the metal casing of the connectors. The casing itself must be connected to the shield braid and to pin 1 of the connectors.

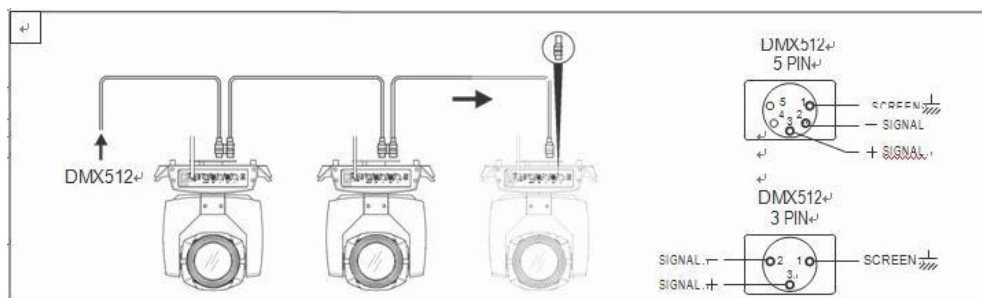

Figure 1 DMX Cable connection

1.6 Rigging (Optional)

This equipment can be positioned and fixed by clamp in every direction of the stage. Locking system makes it easy to fasten to the bracket.

Attention! Two clamps is needed to fix the equipment. Every clamp is locked by fastener of 1/4 kind. Fastener can only be locked clockwise.

Attention! Fasten a safety string to the additional hole of side aluminum piece. The secondary accessory can not hang on the delivery handle. Nip the equipment on bracket.

- Check if rigging clamp (not including the one inside) damaged or not? If stand ten times weight as the equipment. Make sure the architecture can stand ten times weight as all the equipments, clamps, wirings and other additional fixtures.
- Screws for clamping must be fixed firmly. Take one M12 screw (Grade 8.8 or higher) to clamp bracket, and then screw the nuts.

- Level the two hanging points at the bottom of clamp. Insert fastener to the bottom, lock the two levers by 1/4 rotating clockwise; then install another clamp.
- Install on safety string which stands at least ten times weight as equipment. Terminal of the accessory is designed for clamps.
- Make sure pan/tilt lock unlocked or not. Keep the distance more than 1M from equipment to flammable material or lighting source.

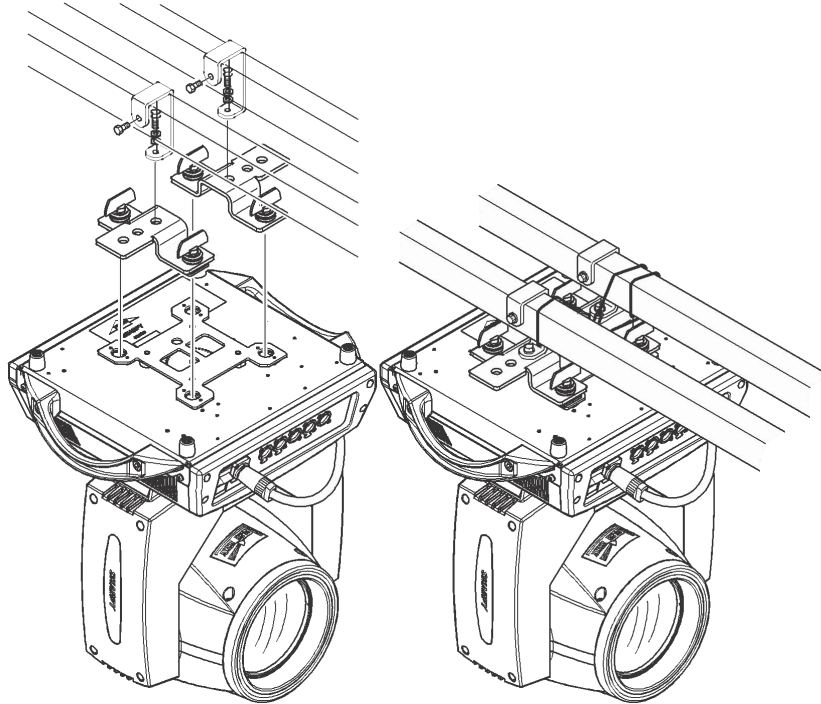

Figure 2 Installation

Chapter 2 Panel operation

2.1 Brief

The light panel diagram show as Figure 3, Left area is TFT Displayer, support touch, and right area is KEY, both of touch and KEY can operate light and setting.

Display & operation just like 'Android operation system', touch the item will set or modify setting.

Note: Prevent damage the touch or TFT displayer, Can not use sharp objects chik displayer.

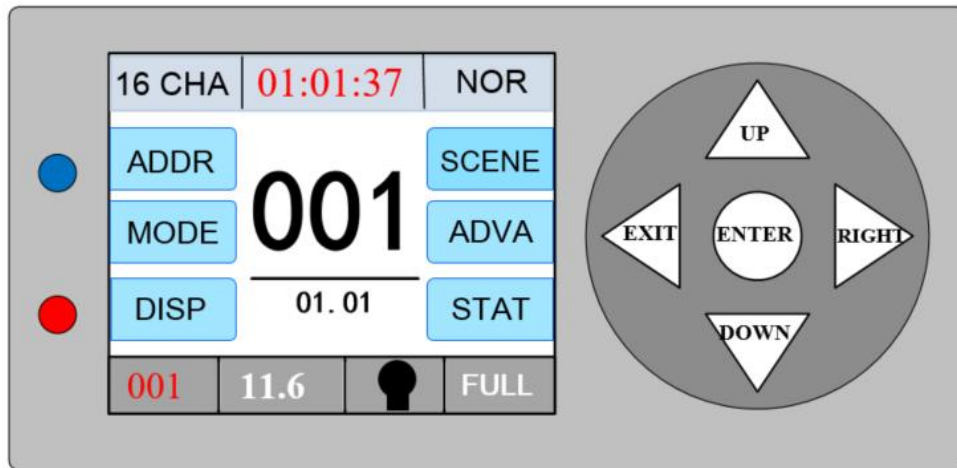

Figure 3 Panel diagram

2.2 Operation

2.2.1 Operate light with touch or KEY

- The left area is TFT Displayer and touch, chik item or value with finger will to complete operation of set light setting(parameters) or view light state.
- The area on the right hand side is 4 KEY, As auxiliary input interface, if disable touch function,, the KEYr can been choose to set the parameter.

2.2.2 Parameter value setting

When the selected item is value need to been modified, the dialog shown in Figure 4 will popup.

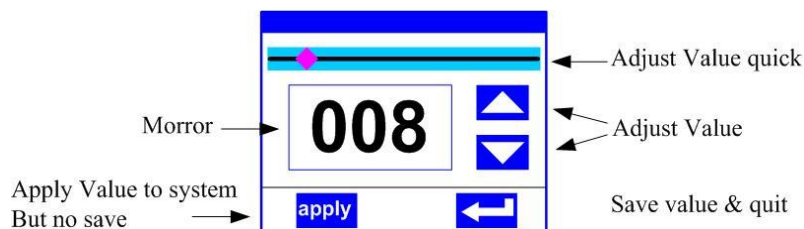

Figure 4 Dialog of value setting

- **Modify value:** Can quickly modify value via pull the slider to the desired position, or click the button of 'up' or 'down' whit finger on the right side to set the exact desired value, another way is roll encoder on the right hand side of panel.
- **Apply value:** When Value had been modified, Then press the bottom of 'apply' in the

left corner to apply to the light, but hav't saved;

- **Save Value:** Any time, click on the lower right corner of the "OK" button, the setting will be saved into internal memory.

2.2.3 Boolean parameter setting

- when the selected parameters is a Boolean value (such as ON or OFF), can directly modify setting by chick corresponding item, the setting will be saved right now.
- When the parameter is a key item, chick corresponding item, a dialog shown in Figure 5 will be popup ask for the confirm. Chick 'sure' to confirm.

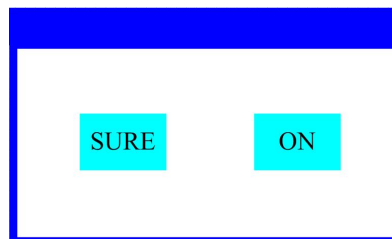

Figure 5 Dialog of confirm

2.2.4 Sub Menu (Parameter)

Chick item of main menu, enter corresponding sub menu, shown in Figure 6, total 6 sub menu, includes class of parameter and status:

- ADDRESS: Set light DMX address.
- WORKMOD: Set light work mode, master or slave mode when in auto run mode.
- DISPLAY: Set display parameter, eg. select language.
- TEST : Used for test light, modify DMX channel data to test function , the corresponding function of reference channel function table.
- ADVANCE: Set light running parameter.
- STATUS: view light current status.

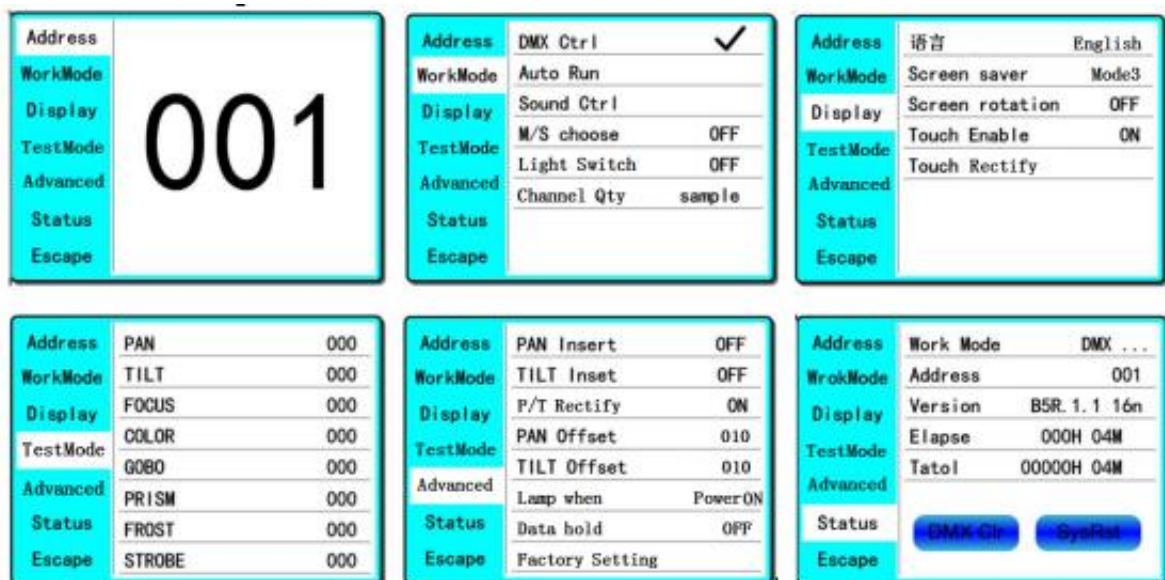

Figure 6 Parameter menu

2.3 Operation and parameter instruction

Via following operation, enter sub menu(parameter menu) shown in Figure 6

- In main menu, click 1/6 function button into corresponding parameter menu.
- In sub menu(page), click main item on the left side of display, can shift to corresponding sub menu(page) quickly.

2.3.1 ADDR--> Address: Set DMX Address

Click and select the "ADDR", can enter the page of DMX address setting, range from 1 to 512, the address code shouldn't is not greater than (512- channels quantity), otherwise the light will not be controlled. Following is the operation:

Enter the page of DMX address, as shown in Figure 7, click the blank area in right side of display will pop-up diglog as in Fig. 4, modify value, then click 'ENTER' to confirm and save DMX address code.

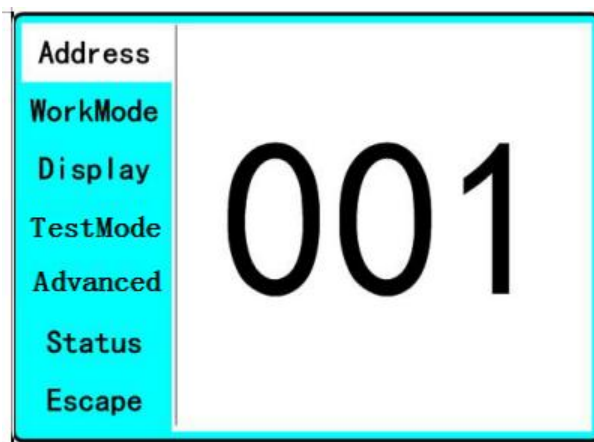

Figure 7 page of DMX Address

2.3.2 MODE--> WorkMode: Set Light work mode

Enter the page of 'WorkMode' as shown in Figure 8 and modify setting. Can set light work mode, control lamp and DMX channel mode.

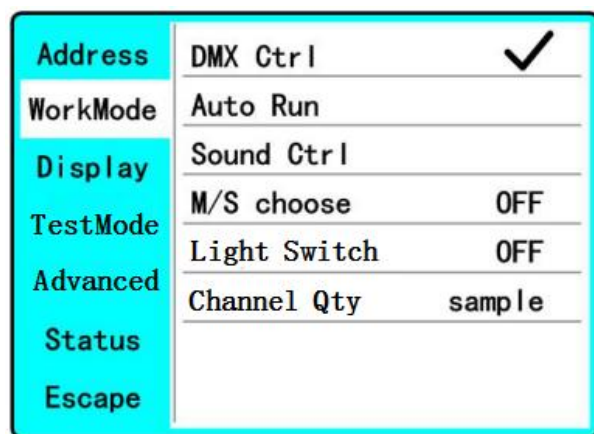

Figure 8 page of work mode

- ◆ **DMX Ctrl:** Choose to set DMX Mode,
- ◆ **Auto Run:** Choose to set Auto Mode,
- ◆ **Sound Ctrl:** Choose to set Sound Mode,
- ◆ **M/S Choose:** Available just in 'AUTO RUN' or 'SOUND Ctrl' mode.
ON--> Master. (Data will be send to other slave lamp immediately.)

OFF--> Slaver.(NOT send data to other lamp via DMX Cable).(Default)

◆ **Light Switch:**

ON--> Turn on the light,
OFF--> Turn off the light.

◆ **Channel Qty:** Light support 2 DMX Channel mode: sample or extend.

Simple --> 16CH.(Default)
Expand--> 20CH(or null).

2.3.3 DISP-->DISPLAY: Set display

Light support 2 language, rotation display , Enter page as shown in Figure9 to set parameter following:

Address	语言	English
WorkMode	Screen saver	Mode3
Display	Screen rotation	OFF
TestMode	Touch Enable	ON
Advanced	Touch Rectify	
Status		
Escape		

Figure9 page of display

◆ **Language:** English / 中文.

◆ **Screen Saver:** when panel is idle(these is no operation in 10 second), displayer will enter saver status.

OFF--> No screen saver.

Mode1--> Power-saving mode, turn off the display.

Mode2--> Displays the current address.

Mode3--> Displays the icon and the current working mode.(Default)

◆ **Screen Rotion: To turning display.**

ON--> Normal display.(Default)

OFF--> 180° turning display.

◆ **Touch enable:** Disable or enable touch function,.

ON--> Enable touch function.(Default)

OFF--> Dosable touch function.

◆ **Touch adjust:** Adjust touch function. Normally, not enter this item.

2.3.4 TEST--> TestMode

Enter the page as shown in Figure 10, Light will into test mode, in this mode, the light does not receive the data for DMX controller.:

Address	PAN	000
WorkMode	TILT	000
Display	FOCUS	000
TestMode	COLOR	000
	GOBO	000
Advanced	PRISM	000
Status	FROST	000
Escape	STROBE	000

Figure 10 page of Test

- ◆ **PAN:** range for 0 to 255;
- ◆ **TILT:** range for 0 to 255;
- ◆ **FOCUS:** range for 0 to 255;
- ◆ **COLOR:** range for 0 to 255;
- ◆ **GOBO:** range for 0 to 255;
- ◆ **PRISM:** range for 0 to 255;
- ◆ **FROST:** range for 0 to 255; ;
- ◆ **STROBE:** range for 0 to 255;

2.3.5 ADVA-->Advanced: Set light run parameter

Enter the page as shown in Figure 10, set the parameter of light:

Address	PAN Inset	OFF
WorkMode	TILT Inset	OFF
Display	P/T Rectify	ON
TestMode	PAN Offset	010
	TILT Offset	010
Advanced	Lamp when	Power ON
Status	Data hold	OFF
Escape	Factory Setting	

Figure 11 page of run parameter

- ◆ **Pan Invert: Reverse PAN move**
 OFF--> Pan Normal move.(Default)
 ON--> Reverse PAN move.
- ◆ **Tilt Invert: Reverse TILT move**
 OFF--> Tilt Normal move.(Default)
 ON--> Reverse Tilt move.
- ◆ **P/T Rectify: Disable or enable position rectify function.**
 OFF--> Disable P/T rectify
 ON--> Enable P/T rectify-(Default)
- ◆ **Pan Offset:** Set PAN original position. **Default: 10**
- ◆ **Tilt Offset:** Set TILT original position. **Default: 10**
- ◆ **Lamp when:**

PowerON--> Turn on the lamp when power on.(Default)

RstDone--> Turn on the lamp after reset.

Manual--> Manually turn on the lamp.

◆ **Data hold:**

OFF--> When no DMX signal,return to middle position.(Default)

ON--> When no DMX signal,stop in the final position.

◆ **Factory Setting:** Restore all parameter to factory setting.

2.3.6 STAT-->Status: View status

Enter the page as shown in Figure 12:

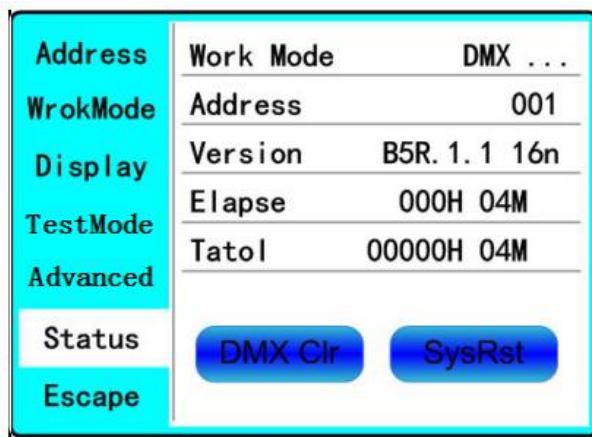

Figure 12 page of status

- ◆ **Work Mode:** Show the current working mode.
- ◆ **Address:** Show the current address.
- ◆ **Version:** Show the version of the lamp.
- ◆ **Elapse:** Working hours after turn on.
- ◆ **Tatol:** Cumulative hours of operation

DMXClr When <Data hold> set <ON>,click to clear DMX data, and make the lamp return to themiddle position.

SysRst Click to reset.

Chapter 3 Channel description

3.1 18 Channel table

Table 1 Channel brief

18CH	22CH	Name	number	describe
CH1	CH1	Color	0-4	White
			5-9	White+Color1
			10-14	Color1
			15-19	Color1+Color2
			20-24	Color2
			25-29	Color2+Color3
			30-34	Color3
			35-39	Color3+Color4
			40-44	Color4
			45-49	Color4+Color5
			50-54	Color5
			55-59	Color5+Color6
			60-64	Color6
			65-69	Color6+Color7
			70-74	Color7
			75-79	Color7+Color8
			80-84	Color8
			85-89	Color8+Color9
			90-94	Color9
			95-99	Color9+Color10
100-104	Color10			
105-109	Color10~Color11			
110-114	Color11			
115-119	Color11+Color12			
120-124	Color12			
125-129	Color12+Color13			
130-134	Color13			
135-139	Color13+Color14			

			9	
			140-144	Color14
			145-149	Color14+White
			150-200	Forwards rainbow from fast to slow
			201-255	Backwards rainbow from slow to fast
CH2	CH2	Strobe	0-3	Close
			4-103	Fadeout slow to fast
			104-107	Open
			108-207	Free Strobe slow to fast
			208-212	Open
			213-251	Pulse Strobe slow to fast
			252-255	Open
CH3	CH3	Dimmer	0~255	Dimmer intensity from 0% to 100%
CH4	CH4	Gobo	0-4	White
			5-9	Gobo1
			10-14	Gobo2
			15-19	Gobo3
			20-24	Gobo4
			25-29	Gobo5
			30-34	Gobo6
			35-39	Gobo7
			40-44	Gobo8
			45-49	Gobo9
			50-54	Gobo10
			55-59	Gobo11
			60-64	Gobo12
			65-69	Gobo13
			70-125	Forwards rainbow from fast to slow
			126-130	Stop
			131-190	Backwards rainbow from slow to fast
191-195	Gobo1 Shake, Slow to fast			

			196-200	Gobo2 Shake, Slow to fast
			201-205	Gobo3 Shake, Slow to fast
			206-210	Gobo4 Shake, Slow to fast
			216-220	Gobo6 Shake, Slow to fast
			221-225	Gobo7 Shake, Slow to fast
			226-230	Gobo8 Shake, Slow to fast
			231-235	Gobo9 Shake, Slow to fast
			236-240	Gobo10 Shake, Slow to fast
			241-245	Gobo11 Shake, Slow to fast
			246-250	Gobo12 Shake, Slow to fast
			251-255	Gobo13 Shake, Slow to fast
CH5	CH5	Prism	0-31	Empty
			32-63	Insert Prism 1
			64-95	Insert Prism 2
			96-127	Insert Prism 3
			128-159	Insert Prism 4
			160-191	Insert Prism 1+2
			192-223	Insert Prism 1+3
			224-255	Insert Prism 1+4
CH6	CH6	Prism 1.Rot	0-127	Prism position
			128-190	Forwards rainbow from fast to slow
			191-192	Stop
			193-255	Backwards rainbow from slow to fast
CH7	CH7	Prism wheel.Rot	0-127	Prism position
			128-190	Forwards rainbow from fast to slow
			191-192	Stop

			2	
			193-255	Backwards rainbow from slow to fast
CH8	CH8	Colorful/ Frost	0-127	empty
			128-190	Frost
			191-255	colorful
CH9	CH9	Zoom	0~255	Zoom Large to small
CH10	CH10	PAN	0~255	Pan movement by 540
CH11	CH11	TILT	0~255	Tilt movement by 270
CH12	CH12	PAN fine	0~255	Fine control of pan movement
CH13	CH13	TILT fine	0~255	Fine control of tilt movement
CH14	CH14	XY Speed	0~255	Macro function
CH15	CH15	Reset	0-25	empty
			26-76	Small motor reset
			77-127	Big motor reset
	240-255		Reset all(over 5 seconds)	
CH16	CH16	Lamp control	0-9	empty
			10-100	Lamp off (Over 3 seconds)
			101-255	Lamp on (Over 3 seconds)
	CH17	XY Speed	0~255	Fast to slow
	CH18	Color wheel speed	0-255	Fast to slow
	CH19	Prism speed	0-255	Fast to slow
	CH20	Gobo wheel speed	0-255	Fast to slow
CH17	CH21	Led Strip	0-255	Effect Show
CH18	CH22	Led Strip Speed	0-255	Effect Show Speed